

# Janus C4 Multi-Blade Controller Installation Guide

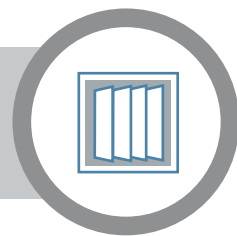

**Part number: JC4-ADV-C2-MLT**

The Janus C4 Multi-Blade Controller is an access control system controller for use with Janus C4 host software. It allows the connection of up to four blades which may be any combination of 2 Door Blades (Part No: JC4-ADV-BL-2D), each supporting 2 doors and 2 readers, OSDP Blades (Part No: JC4-ADV-BL-OSDP), each supporting 2 doors and 4 readers, or I/O Blades (Part No: JC4-ADV-BL-IO16), each supporting up to 8 supervised inputs and 8 volt-free relay outputs.

The Multi-Blade Controller can be used with a number of different power supplies: a 12V external power supply (either 5A or 8A), or POE/POE+. It can be fitted in the standard Grosvenor enclosure (Part No: ADV-ENC) or an alternative enclosure. The controller supports both IP and RS485 host communications (note: if using RS-485 a Line Header will be required).

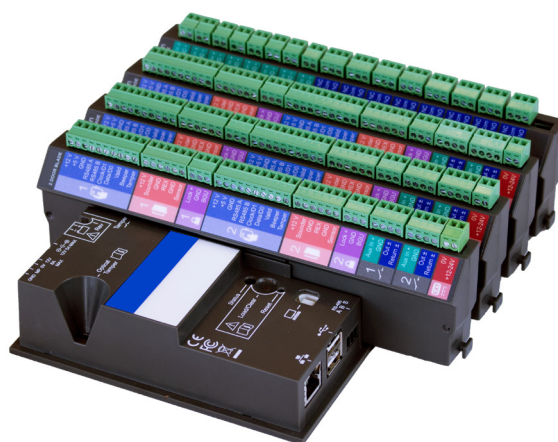

## Specification

Overview	Janus C4 Multi-Blade Controller (max 4 Blade)
Power Input	12V (5A or 8A input), PoE, PoE+
Host Communications	Ethernet 10/100 BASE-T or RS485 2-wire 19.2k baud
Battery (optional)	12V Lead Acid, Reverse Polarity Protection, Health Monitoring
Tamper	Optical Tamper (Grosvenor Enclosure only) and External Tamper Switch (Volt free)
USB	Dual USB 2.0 Type A (future use)
Operating Temperature	0 to +49°C (32 to 120°F)
Humidity	5-85±5% at 30±2°C (86±4°F)
Weight	285g (without enclosure or blades fitted)
Dimensions	Base unit only: 205 x148 x 38 mm, with blades: 205 x 197 x 65 mm

## Electromagnetic Compatibility

This product complies with the following standards, following the provisions of EMC Directive 2014/30/EU:

- EN 55022:2010 Class B
- EN50130-4:2011 inc A1:2014
- IEC 62599-2:2010

## WEEE

Please refer to [www.grosvenortechnology.com/legal-info/](http://www.grosvenortechnology.com/legal-info/) for disposal instructions under EU Directive 2012/19/EU



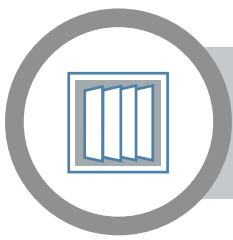

# Connections

## Tamper

The physical tamper can be connected when a non-Grosvenor enclosure is used.

## Power In

12V 8Amp (96W max) or 12V 5Amp.  
For full details of power requirements and options, see page 4.

## Battery

A 12V lead-acid back-up battery may be fitted. An LED indicates if the battery is fitted the wrong way round.  
See *Notes* on page 3.

## Blade Connection

Up to four Door Blades and/or I/O blades can be installed. See *Blade Installation Guides* for more detail.

## Optical Tamper

No connection is needed; the optical tamper is operational when the case is closed.

## Status LED

The Controller Status LED reports the controller state.  
See *Notes* on page 4.

## Load/Clear

Used to reset configuration data.

See How to initialise a controller below.

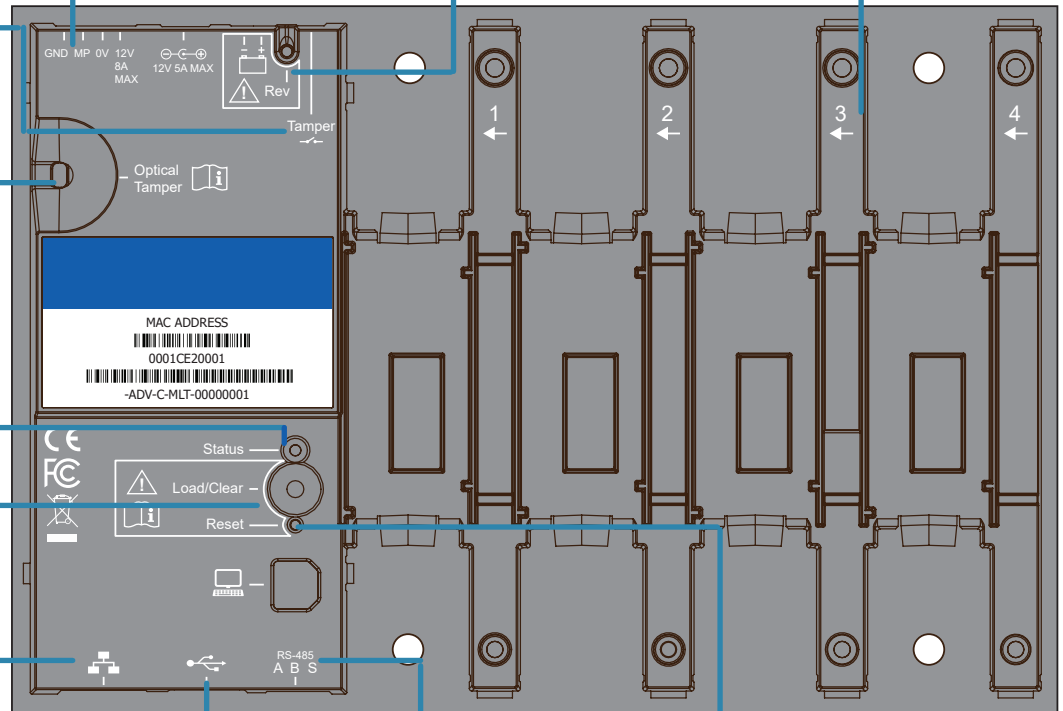

## Ethernet Port

Used for IP host comms and required for configuration.  
10/100 BASE-T  
Full duplex, POE/POE+

Ethernet Port indicators are as shown below:

## USB Ports

Two USB 2.0 Type A ports; intended for Grosvenor-approved products only.  
Can be used to update controller firmware.  
See page 4

## RS485 Port

Used for host communications when RS485 is used to connect controllers.  
See page 4.

## Reset

The Reset button triggers a complete system reboot in the case of an unresponsive system. It is recessed to prevent accidental activation and can be depressed using a suitable tool.

Warning: Use only when requested by Grosvenor Technical Support.

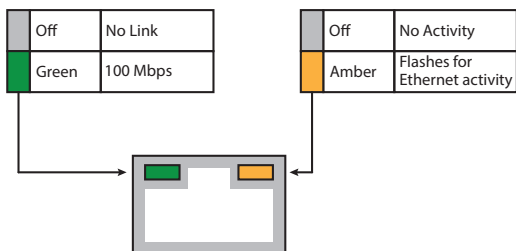

## How to initialize a controller

To initialise the controller and delete all data:

- Press the Load / Clear button while powered off and then power on. Hold until LED goes amber and then flashes amber, after about 20 seconds, then release button.

The button is recessed to prevent accidental activation.



The Janus C4 Multi-Blade Controller has a sophisticated power management system with a choice of input sources. As well as supplying the power used by the controller, it powers up to 4 blades, which may have various locks, readers and peripherals connected.

## Input Power

Power to the controller may be provided by one of the following:

- 12V 5Amp (60W max). 2.1mm Circular Jack (centre pin positive). Normally sufficient when Grosvenor enclosure and power supply are used (5A rated).
- 12V 8Amp (96W max) 4 Way 3.5mm Screw Terminal. Pin1 = +12V, Pin 2 = GND, Pin 3 = PPI, Pin 4 = CHASSIS. Can be used as an alternative PSU if more than 5A is required, e.g. if the locks used require more current. This option can have an external battery back-up.
- PoE (IEEE 802.3.af = 12.95W max)
- PoE+ (IEEE 802.3.at = 25.5W max)
- If fitted, a 12V Sealed Lead Acid Battery (during power outage only)

It is the responsibility of the installer to ensure sufficient power is available for the system. When selecting a suitable power supply, installers need to balance the convenience of PoE power against the total requirements. Ensure you consider the power requirements for the controller itself and the blades fitted, as well as all required locks, readers, etc.

## Output Power

Power outputs are:

- Janus C4 Multi-Blade Controller quiescent power = 300 mA max @ 12V (3.6W)
- Battery charging power, User Selectable (if fitted, only if battery depleted) = to 1A max @ 12V (12W)
- USB Power = 260mA max @ 12V (3.1W)
- Blade Power (refer to Blade Installation Guides)

## Battery

A 12V lead-acid back-up battery may be fitted. An LED indicates if the battery is fitted the wrong way around. The battery is typically 7Ah sealed lead acid, though capacity may vary depending on requirements. The system performs periodic health checks to check battery status.

Using a battery ensures continuing power to controller and all attached devices during power outages. Note though that all system data is retained in non-volatile memory indefinitely even when no battery is fitted.

Power supply	Supplied		Used by controller*		Remaining for devices	
PoE (IEEE 802.3.af )	11W	0.9A	16.6W	1.4A	**	**
PoE+ (IEEE 802.3.at)	21W	1.75A	16.6W	1.4A	4.4W	0.35A
12V external power supply (5A)	60.0W	5.0A	16.6W	1.4A	43.4W	3.6A
12V external power supply (8A)	96.0W	8.0A	16.6W	1.4A	79.4W	6.6A

\* Indicates the approximate power required by the controller, assuming three Door Blades and one I/O Blade fitted, and allowing for standard battery charging power.

\*\* PoE is not recommended for fully-populated multi-blade controllers as it does not provide sufficient power.

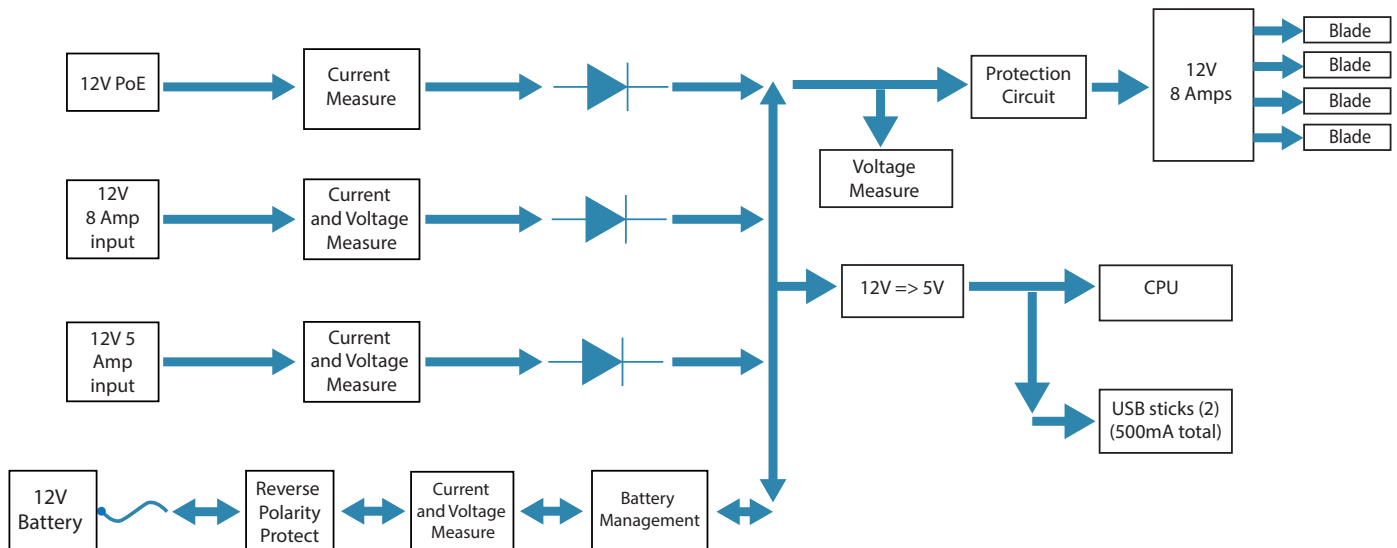

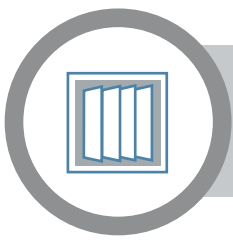

# Notes

## RS485 Connections

If RS485 is used, up to 6 Advance controllers (either Single or Multis) can be daisy-chained together on a 485 line from a Line Header.

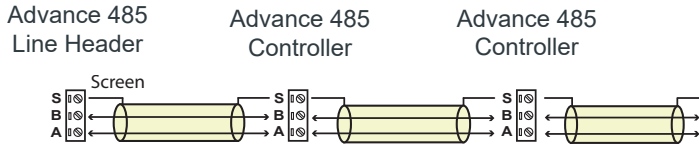

- A 485 Line Header must be configured before attempting to add RS-485 controllers.
- Please see the Line Header Installation Guide for more information.

**Note:** That the 485 Line Header doesn't have to be at the bus end, it can be anywhere. Fit a 120 ohm termination resistor at either end of the RS485 bus:

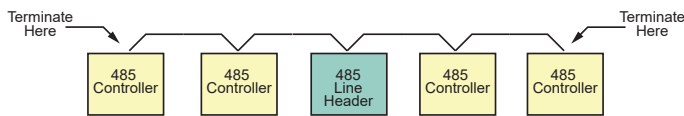

**Note:** That all Janus C4 485 controllers require an Ethernet connection during the commissioning process.

Use Janus C4 Configurator to discover and bring the controller online. Once set up as the correct type and with the correct network settings, the Ethernet connection can be disconnected from 485 controllers.

## Status LED

The Controller Status LED can be monitored during installation and set up. It is not visible when the case is closed. The LED reports the controller state as follows:

Yellow medium flash	Off-line
Yellow fast flash	Port connected, not online
Green medium flash	On-line
Green continuous	Controller initialising
Blue medium flash	Application initialising
Cyan fast flash	Wants data download
White fast flash	Data download in progress
White slow flash	Firmware update in progress
Red continuous	Configuration button pressed for less than 5 seconds
Red fast flash	Configuration button pressed for more than 5 seconds
Red slow flash	Error

## Updating Firmware

The Controller firmware cannot be updated over a 485 connection as the files are too large.

If a firmware update is required while the controller has an IP connection the **Update Firmware** button will appear within the Quick Start app, enabling the process to be completed easily.

If a firmware update is needed subsequently, the firmware can be updated locally using a USB stick. This is a FAT32 formatted USB stick with firmware/app files in a "firmware" directory in the root directory.

## To update firmware

1. Open Janus C4 UI and select Navigation > Devices
2. On the Devices tab, choose Controller and Right-click and select the Commands Option
3. Click the option Arm
4. At this point, insert the supplied USB stick into the controller.

**Note:** You must insert the USB stick within one hour of selecting the Arm option. Note that no messages appear in Janus C4 during this process.

5. While the firmware file is being downloaded, the controller LED will show a slow white flash. When it is complete the LED shows a fast red flash. At this point you can remove the USB stick. If the USB stick is removed before the process is complete, the firmware will not be updated.

No messages are shown on the Janus C4 user interface.

For more information about Janus C4, visit the website or contact Technical Support:

Email: [info@grosvenortechnology.com](mailto:info@grosvenortechnology.com)  
 Telephone: +44 (0)1279 838000  
 Web: [www.grosvenortechnology.com](http://www.grosvenortechnology.com)

